

Emerson[®]

MICRO CD SYSTEM

with DIGITAL TUNER,

THINOVATION™

FLAT PANEL SPEAKERS

and BUILT IN SUBWOOFER

OWNER'S MANUAL

ES88

Visit our web site at www.emersonradio.com



CAUTION

TO PREVENT FIRE OR SHOCK HAZARD, DO NOT USE THIS PLUG WITH AN EXTENSION CORD, RECEPTACLE OR OTHER OUTLET UNLESS THE BLADES CAN BE FULLY INSERTED TO PREVENT BLADE EXPOSURE. TO PREVENT FIRE OR SHOCK HAZARD, DO NOT EXPOSE THIS APPLIANCE TO RAIN OR MOISTURE.



The lightning flash with arrow-head symbol, within an equilateral triangle is intended to alert the user to the presence of uninsulated 'dangerous voltage' within the product's enclosure that may be of sufficient magnitude to constitute a risk of electric shock to persons.

CAUTION

RISK OF ELECTRIC SHOCK
DO NOT OPEN

WARNING: TO REDUCE THE RISK OF ELECTRIC SHOCK DO NOT REMOVE COVER (OR BACK), NO USER SERVICEABLE PARTS INSIDE REFER SERVICING TO QUALIFIED SERVICE PERSONNEL.



The exclamation point within an equilateral triangle is intended to alert the user to the presence of important operating and maintenance (servicing) instructions in the literature accompanying the appliance.

IMPORTANT SAFETY INSTRUCTIONS

- 1.) Read these instructions.
- 2.) Keep these instructions.
- 3.) Heed all warnings.
- 4.) Follow all instructions.
- 5.) Do not use this apparatus near water.
- 6.) Clean only with dry cloth.
- 7.) Do not block any ventilation openings. Install in accordance with the manufacturer's instructions.
- 8.) Do not install near any heat sources such as radiators, heat registers, stoves, or other apparatus (including amplifiers) that produce heat.
- 9.) Do not defeat the safety purpose of the polarized or grounding-type plug. A polarized plug has two blades with one wider than the other. A grounding type plug has two blades and a third grounding prong. The wide blade or the third prong are provided for your safety. If the provided plug does not fit into your outlet, consult an electrician for replacement of the obsolete outlet.
- 10.) Protect the power cord from being walked on or pinched particularly at plugs, convenience receptacles, and the point where they exit from the apparatus.
- 11.) Only use attachments / accessories specified by the manufacturer.
- 12.) Unplug this apparatus during lightning storms or when unused for long periods of time.
- 13.) Refer all servicing to qualified service personnel. Servicing is required when the apparatus has been damaged in any way, such as power-supply cord or plug is damaged, liquid has been spilled or objects have fallen into the apparatus, the apparatus has been exposed to rain or moisture, does not operate normally, or has been dropped.
- 14.) This appliance shall not be exposed to dripping or splashing water and no object filled with liquids such as vases shall be placed on the apparatus.
- 15.) Do not overload wall outlet. Use only power source as indicated.
- 16.) Use replacement parts as specified by the manufacturer.
- 17.) The product may be mounted to a wall only if recommended by the manufacturer.
- 18.) Upon completion of any service or repairs to this product, ask the service technician to perform safety checks.

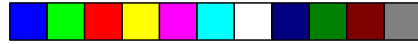

Thank you.....

For purchasing this Emerson Micro Audio System with the unique Thinovation™ flat panel speakers. We think you will be truly amazed by the sound produced by this very compact tabletop system.

This system includes a digital tuner with 20 preset station memory, a CD player with 20 track programmable memory, a clock timer so that you can set to sleep or wake to the radio or your favorite CD, a built in compact subwoofer for dynamic bass, and a full function remote control.

Please make sure to read this manual carefully and completely to make sure that you understand all the functions we have included in this system and get the maximum enjoyment from all the outstanding features.

This system was in perfect working order when it left our factory. If you encounter any problems with the set-up or operation of this system, **please do not return it to the retail store.** Please call the Emerson Research Customer Service Hot Line Toll Free at 800-898-9020. One of our service representatives will try to diagnose and correct the problem for you.

Once again, thanks for purchasing this Emerson audio product.

For future reference, record the serial number in the space provided.

Model No: ES88

Serial No: _____

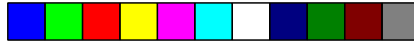

IMPORTANT NOTES

- Avoid installing this unit in places exposed to direct sunlight or close to heat radiating appliances such as electric heaters, on top of other stereo equipment that radiates too much heat, places lacking ventilation or dusty areas, places subject to constant vibration and/or humid or moist areas.
- Do not attempt to clean this unit with chemical solvents as this might damage the finish. Use a clean dry cloth.
- Operate controls and switches as described in the manual.
- Before turning 'On' the power, make certain that power cord is properly installed.
- Store your CDs, in a cool area to avoid damage from heat.
- When moving the set, be sure to first disconnect the power cord.

CLASS 1 LASER PRODUCT

CLASS 1 LASER PRODUCT
APPAREIL À LASER DE CLASSE 1
PRODUCTO LASER DE CLASE 1

CAUTION
INVISIBLE LASER RADIATION
WHEN OPEN AND INTERLOCKS
DEFEATED.
AVOID EXPOSURE TO BEAM



This product contains a low power Laser Device.

FCC INFORMATION

This equipment has been tested and found to comply with the limits for a Class B digital device, pursuant to Part 15 of the FCC Rules. These limits are designed to provide reasonable protection against harmful interference in a residential installation. This equipment generates, uses, and can radiate radio frequency energy and, if not installed and used in accordance with the instructions, may cause harmful interference to radio communications. However, there is no guarantee that interference will not occur in a particular installation. If this equipment does cause harmful interference to radio or television reception, which can be determined by turning the equipment off and on, the user is encouraged to try to correct the interference by one or more of the following measures:

- Reorient or relocate the receiving antenna.
- Increase the separation between the equipment and receiver.
- Connect the equipment into an outlet on a circuit different from that to which the receiver is connected.
- Consult the dealer or an experienced radio/TV technician for help.

This device complies with Part 15 of the FCC Rules. Operation is subject to the following two conditions:

- (1) This device may not cause harmful interference, and
- (2) This device must accept any interference received, including interference that may cause undesired operation.

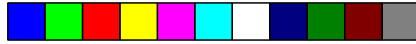

PREPARATION FOR USE

UNPACKING AND SET UP

- This system consists of the following components: Tuner/CD Player unit with built in subwoofer, a single Thinovation™ Flat Speaker Panel, a full-function Remote Control and a detachable AC power cord.

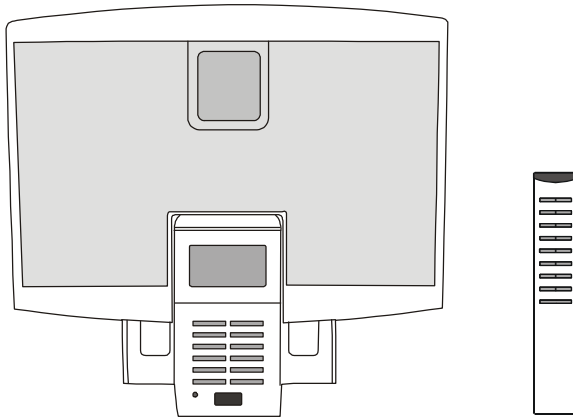

Carefully remove all the components from the display carton and verify that you have all the necessary components before you dispose of the display carton.

- Remove all packing materials from the individual components. Remove any descriptive labels that may be attached to the front panel of the main unit. Do not remove any labels or stickers on the back panels of the main unit or the speakers.
- Place all the components in the desired location. This system is designed to be used on level, stable, flat surface such as a table, desk, shelf, or stand, convenient to an AC outlet, out of direct sunlight, and away from sources of excess heat, dust, moisture, or vibration.
- Unwind the lead wire FM antenna on the back of the Tuner/CD Player unit and extend it to its full length.
- The main unit is shipped with a “dummy CD” display card in the CD player. This “dummy CD” card must be removed before you can use the CD player.



FLAT PANEL SPEAKER CONNECTION

IMPORTANT: CONNECT THE SPEAKER PANEL TO THE MAIN UNIT BEFORE YOU CONNECT THE AC POWER CORD TO THE AC OUTLET.

The Thinovation™ Speaker Panel not only contains the left and right wide range speakers, it also serves as the CD compartment cover. To install the Thinovation™ Speaker Panel on the main unit simply slide the Thinovation™ Speaker Panel down ward on the speaker mounting bracket as shown so that the two plugs on the top of the mounting bracket fit into the two jacks on the bottom of the speaker panel. You may tilt the mounting bracket forward to make this operation easier if necessary.

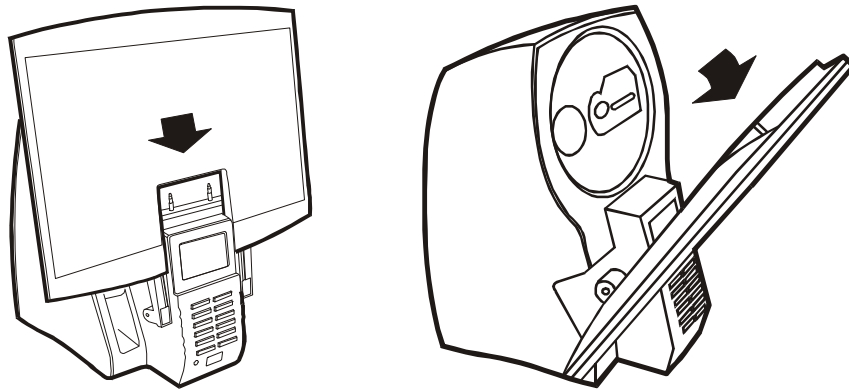

After the panel is mounted on the bracket you should lock the panel in place by sliding the two locking switches on the back of the panel 'inward' so they fit into the corresponding 'notches' on the sides of the mounting bracket.

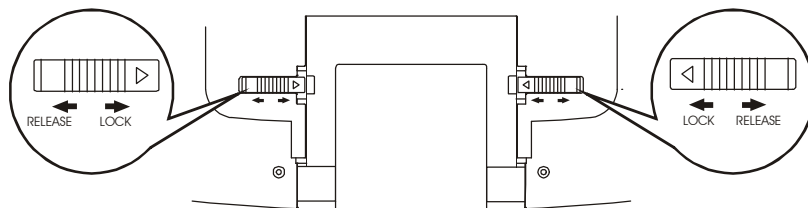

IMPORTANT: Remember to unlock these two switches before you try to remove the speaker panel from the mounting bracket.



POWER SOURCE

This system is designed to operate on 120V AC 60Hz house current only. Connecting this system to any other power source may cause damage to the system and such damage is not covered by your warranty.

Unwind the AC power cord and extend it to its full length. Connect the small female type plug on one end of the cord to the AC jack on the back panel. The plug can only be inserted in the jack one way. If the plug does not seem to fit into the jack correctly, turn the plug over and try again. The plug must be fully inserted into the jack or the system will not operate.

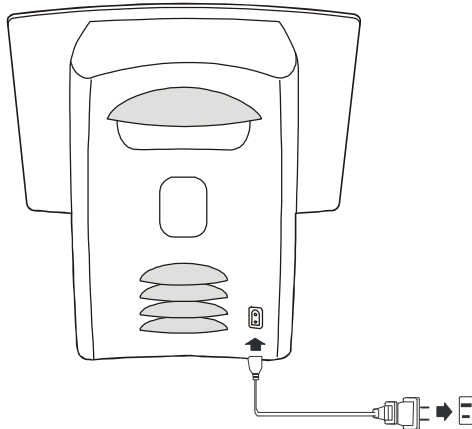

NOTE: The system has polarized AC plug with one wide blade and one narrow blade. The plug will only fit into matching polarized AC outlets. This is a safety feature to reduce the possibility of electric shock. If the plug will not fit in your AC outlets, you probably have outdated non-polarized outlet. You should have your outdated outlet changed by a qualified, licensed electrician. Do not file the wide blade on the plug, or use an adapter to make the plug fit into your outlet. This defeats the safety feature and could expose you to electric shock.

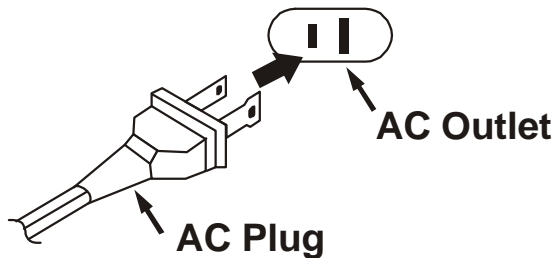



PROTECT YOUR FURNITURE

This model is equipped with non-skid rubber 'feet' to prevent the product from moving when you operate the controls. These 'feet' are made from non-migrating rubber material specially formulated to avoid leaving any marks or stains on your furniture. However certain types of oil based furniture polishes, wood preservatives, or cleaning sprays may cause the rubber 'feet' to soften, and leave marks or a rubber residue on the furniture. To prevent any damage to your furniture we strongly recommend that you purchase small self-adhesive felt pads, available at hardware stores and home improvement centers everywhere, and apply these pads to the bottom of the rubber 'feet' before you place the product on fine wooden furniture.



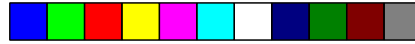

INSTALLING THE REMOTE CONTROL BATTERIES

- 1.) Slide the door in the direction of the arrow.
- 2.) Insert two “AAA” batteries in the compartment. Follow the polarity markings engraved inside the compartment. If the batteries are inserted incorrectly the remote control will not work.
- 3.) Replace the battery door.

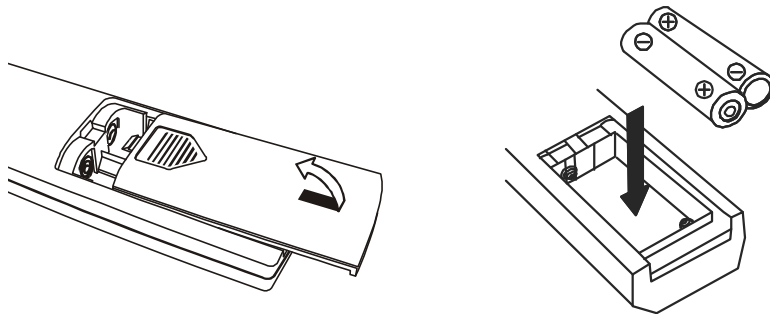

Notes: Use a well-known brand of alkaline batteries for longest life and best performance. When the remote operation becomes intermittent replace both batteries at the same time. Do not mix different types of batteries, such as alkaline and carbon zinc batteries.

BATTERY PRECAUTIONS

Follow these precautions when using batteries in this device:

1. Use only the size and type of batteries specified.
2. Be sure to follow the correct polarity when installing the batteries as indicated in the battery compartment. Reversed batteries may cause damage to the device.
3. Do not mix different types of batteries together (e.g. Alkaline and Carbon-Zinc) or old batteries with fresh ones.
4. If the device is not to be used for a long period of time, remove the batteries to prevent damage or injury from possible battery leakage.
5. Do not try to recharge batteries not intended to be recharged; they can overheat and rupture. (Follow battery manufacturer's directions.)

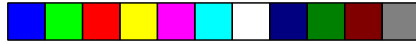

LOCATION OF CONTROLS AND INDICATORS

FRONT VIEW

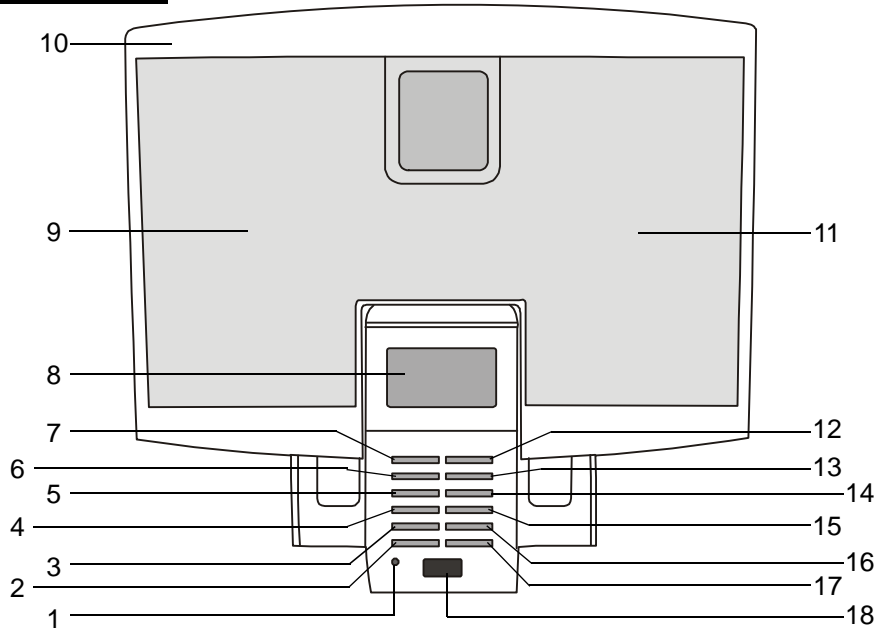

BACK VIEW

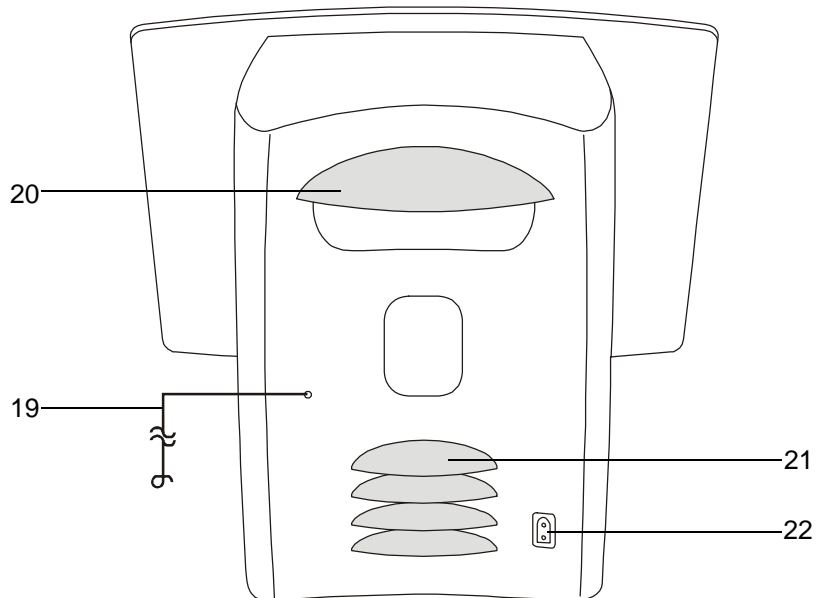



- 1.) **STANDBY** LED Indicator.
- 2.) **POWER/STANDBY** Button.
- 3.) **CD** Button.
- 4.) **VOLUME –** Button.
- 5.) **M-UP/REPEAT** Button.
- 6.) **⏮ R-SKIP/DOWN** Button.
- 7.) **■ STOP/BAND** Button.
- 8.) Multi-Function LCD Display.
- 9.) Left Speaker.
- 10.) CD Door.
- 11.) Right Speaker.
- 12.) **▶⏪ PLAY/PAUSE** Button.
- 13.) **▶▶ F-SKIP/UP** Button.
- 14.) **MEMORY/CLOCK-ADJ.** Button.
- 15.) **VOLUME +** Button.
- 16.) **TUNER** Button.
- 17.) **SLEEP/TIMER** Button.
- 18.) Remote Sensor.
- 19.) FM Wire Antenna.
- 20.) Carrying Handle.
- 21.) Subwoofer.
- 22.) AC Cord Socket.

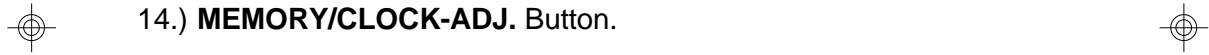

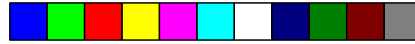

REMOTE CONTROL

- 1.) **SNOOZE** Button.
- 2.) **VOL** (Volume) – Button.
- 3.) **◀◀ R-SKIP/DOWN** Button.
- 4.) **■ STOP/BAND** Button.
- 5.) **RANDOM** Button.
- 6.) **MEMORY/CLOCK-ADJ.** Button.
- 7.) **DISPLAY** Button.
- 8.) **FUNCTION** Button.
- 9.) **MUTE** Button.
- 10.) **POWER/STANDBY** Button.
- 11.) **SLEEP** Button.
- 12.) **TIMER** Button.
- 13.) **M-UP/REPEAT** Button.
- 14.) **INTRO** Button.
- 15.) **▶▶ PLAY/PAUSE** Button.
- 16.) **▶▶ F-SKIP/UP** Button.
- 17.) **VOL** (Volume) + Button.
- 18.) Battery compartment (Back Cabinet).

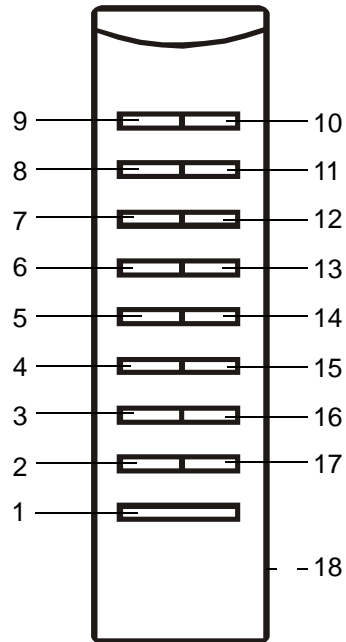

NOTES:

The remote control must be pointed at the remote sensor on the lower part of the front panel. The effective operating range of the remote control is approximately 15 feet. The effective operating angle is approximately 15 degrees to the left or right of 'dead center'.

When the operation of the remote control becomes intermittent, or the operating range of the remote is reduced, replace the batteries.

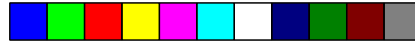

OPERATING INSTRUCTIONS

- **Make sure the Thinovation™ Speakers Panel is properly mounted and locked onto the speaker mounting bracket.**
- **Make sure that the FM antenna wire is fully unwound and extended.**
- **Make sure that you have installed the batteries in the remote control.**
- **Make sure that the AC power cord is properly connected to the AC socket on the back panel, and to a 120V 60Hz household AC power outlet.**

USING THE CONTROLS

Most of the functions of this system can be operated by pressing the buttons on the front panel, or the corresponding buttons on the remote control handset. If a particular function can only be operated by controls on the main unit or controls on the remote, the instructions will specify:

“MAIN UNIT ONLY” or **“REMOTE CONTROL ONLY”**

ELECTRONIC VOLUME CONTROL

Press the VOLUME + or – buttons on the front panel or the remote control to increase or decrease the volume. The volume level indicator appears in the main display. The range is from “00 db” (Minimum) to “80 db” (Maximum). The system remembers the volume level when the power is switched ‘Off’ and returns to the same level when the power is switched ‘On’ again.





SETTING THE CLOCK

When the system is connected to the AC outlet for the first time the STANDBY LED indicator on the front panel glows red and “0:00” appears on the display. This is your indication that the time display is incorrect and needs to be reset.

NOTE:

The clock can only be set while the system is in the Standby (Power ‘Off’) mode.

- 1.) Press the MEMORY/CLOCK-ADJ. button on the front panel or the remote control **for at least 3 seconds.**



“24H” will begin flashing in the display indicating that the clock is set for 24-hour “European” time.

(Example: 6:00 PM is shown as 18:00)

- 2.) Press either the ►► F-SKIP/UP or ◀◀ R-SKIP/DOWN button on the front panel of the main unit or on the remote control once to change the clock format to 12 Hour “American” time. The display will change from “24H” to “12H”.



- 3.) Press the MEMORY/CLOCK-ADJ. button again. The Hour digits will begin flashing.





4.) Press the ►► or ◄◄ buttons on the front panel of the main unit or on the remote control to set the display to the correct Hour, AM or PM.

5.) Press the MEMORY/CLOCK-ADJ. button again. The Minute digits will begin flashing.

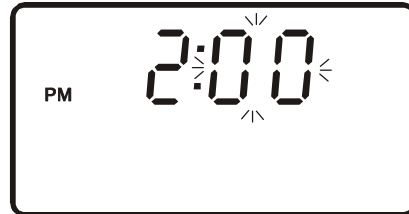

6.) Press the ►► or ◄◄ buttons on the front panel of the main unit or on the remote control to set the display to the correct Minute.



7.) Press the MEMORY/CLOCK-ADJ. button once more. The time display stops flashing and the clock begins to run.

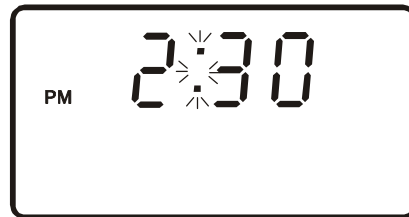

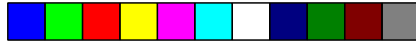

LISTENING TO THE RADIO

1.) Press the POWER/STANDBY button on the main unit or the remote control. The main display turns on.

2.) If necessary, press the TUNER button on the front panel of the main unit or the FUNCTION button on the remote control to select the Tuner function. The display will show an AM or FM station frequency. To select a different band, press the ■ STOP/BAND button.



3.) Tune to the desired frequency as follows:

- **Manual Tuning**

Repeatedly press the ►► or ◄◄ buttons on the front panel of the main unit or on the remote control until the frequency of the desired station appears on the display.

- **Automatic Tuning**

Press and hold the ►► or ◄◄ buttons on the front panel of the main unit or on the remote control until the display begins to move, then release the buttons. The tuner will search up or down the band for the next strong station and stop on that station. Repeat this procedure until the tuner stops on your desired station.

4.) Adjust the VOLUME controls as desired. If you tuned to an FM Stereo station the **ST** indicator will appear in the main display.

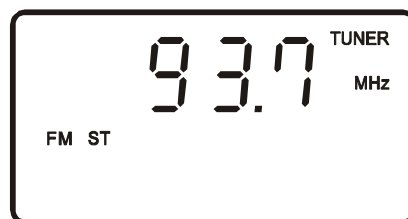

5.) When you are finished listening press the POWER/STANDBY button on the main unit or remote control to return to the Standby (Power Off) mode. The main display goes off and the time display reappears.

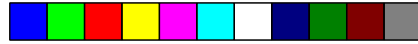

ANTENNA INFORMATION

FM

Make sure the FM lead wire antenna is unwound and extended to its full length. It may be necessary to vary the direction of this wire antenna until you find the position that provides the best reception for your favorite FM stations.

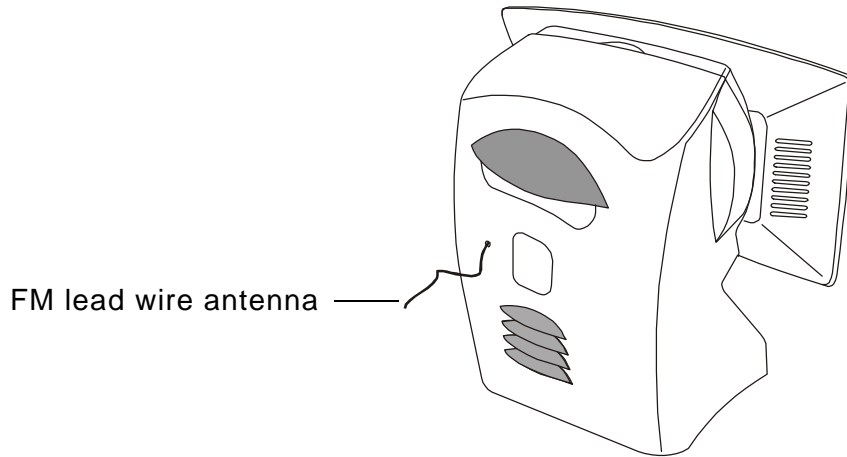

AM

The AM ferrite bar antenna is inside the main unit. IF AM reception is unsatisfactory, you may have to turn the main unit slightly until you find the position that provides the best reception.

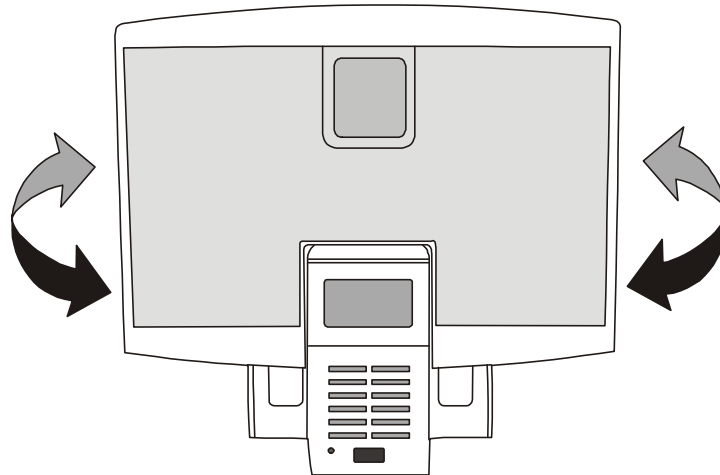

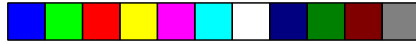

PRE-SETTING STATIONS IN THE TUNER MEMORY

This system includes a 20 station preset memory. You can store up to 10 FM stations and 10 AM stations in the tuner memory for immediate recall. The procedure for storing stations in memory is as follows:

- 1.) Follow step 3 under "LISTENING TO THE RADIO" on page 15 to select the first station you wish to memorize.

Example: FM 103.5 MHz.



- 2.) When the desired station appears on the display press the MEMORY/CLOCK ADJ. button on the front panel or the remote control. The MEMORY indicator flashes and Preset Memory Number 01 appears in the display.

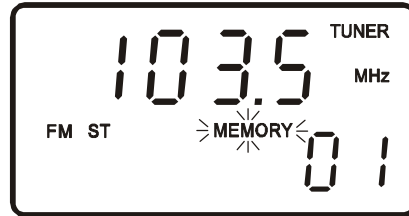

- 3.) Press the MEMORY/CLOCK ADJ. button once more to enter your station in preset memory number 01.

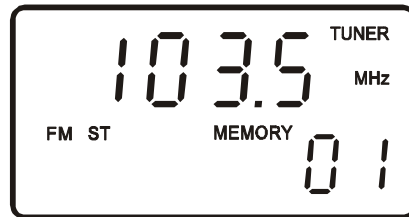

- 4.) Tune to the next station you wish to memorize. When the desired station appears on the display press the MEMORY/CLOCK ADJ. button to start the MEMORY indicator flashing, and then press the M-UP/REPEAT button to select a different preset memory number.

(Each time you press the M-UP/REPEAT button the preset memory number display advances by 1.)

- 5.) Press the MEMORY/CLOCK ADJ. button again to enter the station in the selected preset memory number.

- 6.) Repeat steps 4 and 5 until you have memorized up to 10 stations on the FM band, then press the ■ STOP/BAND button to switch to the AM band and follow the same procedure to enter up to 10 stations on the AM band.





RECALLING PRESET STATIONS

Turn the system 'On' and select the desired band. Press the M-UP/REPEAT button repeatedly to scroll through the preset memories until the display shows the desired station.

CHANGING PRESET STATIONS

To change any preset station memory select the desired band and tune to the new station you wish to memorize. Press the MEMORY/CLOCK ADJ. button and then press the M-UP/REPEAT button to display the memory number you wish to change. Press the MEMORY/CLOCK ADJ. button again to enter the new station in the memory. The new station is memorized and the previous station is deleted from the memory.



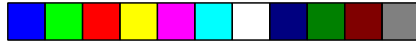

PLAYING COMPACT DISCS

IMPORTANT: This CD player can play normal CDs plus CD Recordable (CD-R) and CD Rewriteable (CD-RW) discs. However the playability of CD-R and CD-RW discs may be affected by the type of software that was used in 'ripping' the tracks from the original discs and 'burning' the tracks onto the blank media. Playability may also be affected by the quality and condition of the blank media you use for recording. 100% compatibility cannot be guaranteed. This is not an indication of any problems with your player.

NOTE: You must remove the 'dummy CD' display card from the CD player before loading your own CDs.

- 1.) Press the POWER/STANDBY button to turn the system 'On'.
- 2.) Press the CD button on the front panel of the main unit or the FUNCTION button on the remote control to select the CD function.
- 3.) Tilt the Thinovation™ Speaker Panel forward as far as it will go to expose the CD compartment.

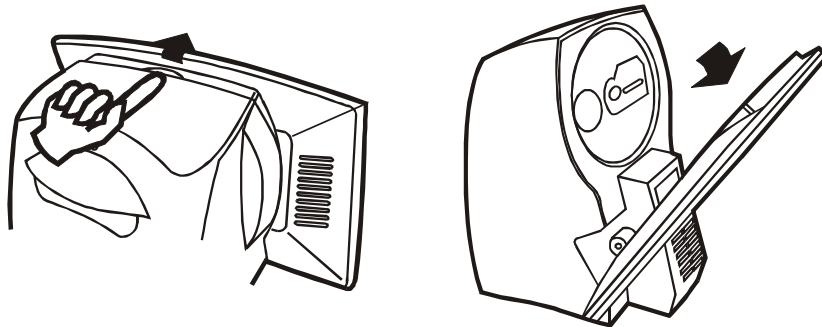

- 4.) Place a CD on the center spindle with the printed label side facing up. Press down near the center hole of the CD to make sure it is properly seated on the spindle.

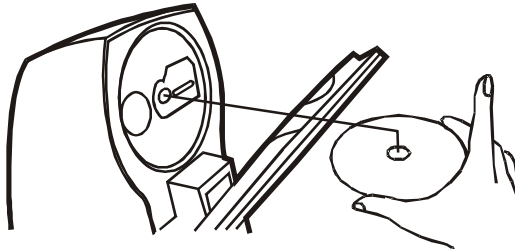

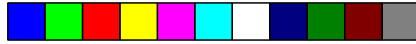

- 5.) Close the front panel. The disc will spin and zeros will flash in the track number and time display. Within a few seconds the disc will stop spinning and the display will show the total playing time and total tracks on the disc.

Note: If the disc is inserted upside down or if the disc is badly scratched and unreadable, playback will not be possible. In this case the main display will show "dISC no". Remove the disc and re insert it properly, or try another disc.

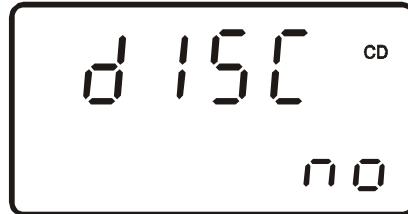

- 6.) Press the PLAY/PAUSE **▶||** button on the front panel of the main unit or on the remote control to begin playback on track 1. The display will show the elapsed playing time of each track as it plays.



- 7.) Adjust the VOLUME controls as desired.

- 8.) When the last track has played the player stops automatically and the display again shows the total playing time and tracks on the disc. You may also stop playback at any time by pressing the **■** STOP/BAND button on the front panel of the main unit or on the remote control.

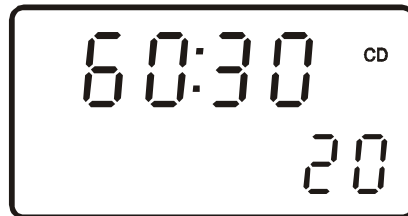

- 9.) When you are finished listening tilt the front panel forward, remove your disc and close the front panel again.

- 10.) Press the POWER/STANDBY button to return the system to the Standby (Power Off) mode.

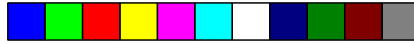

PAUSE CONTROL

To pause momentarily during CD playback press the PLAY/PAUSE **▶||** button on the front panel of the main unit or the remote control again. The sound stops and the elapsed time display flashes but the disc continues to spin. Press the PLAY/PAUSE **▶||** button once more to cancel Pause mode and resume playback. The elapsed time display stops flashing.



SKIP/SEARCH CONTROLS (▶▶/◀◀)

To skip to higher or lower numbered tracks during playback repeatedly press the **▶▶** or **◀◀** buttons on the front panel of the main unit or the remote control until the desired track number appears in the display. Playback will begin on the desired track.

To perform high speed search within a track to locate a specific musical passage depress and hold the **▶▶** or **◀◀** buttons on the front panel of the main unit or the remote control. The player will move rapidly forward or backward as long as the buttons are depressed. When you hear the desired passage release the buttons and normal playback will resume at that point.

TO START PLAYBACK ON A SPECIFIC TRACK

Load the disc as usual and wait until the total playing time and track numbers appear on the display. Press the **▶▶** or **◀◀** buttons on the front panel of the main unit or the remote control until the desired track number appears in the display, then press the PLAY/PAUSE **▶||** button to begin playback on that track.



REPEAT PLAYBACK

You can program the player to continuously repeat a single track or the entire disc. The Repeat function can be activated while a disc is playing or while the disc is stopped.

One Track Repeat

Press the **▶▶** or **◀◀** buttons on the front panel of the main unit or the remote control until the desired track number appears in the display, then press the M-UP/REPEAT button once. The REPEAT indicator flashes in the display. Press the PLAY/PAUSE **▶▶** button to begin playback on that track. The selected track will be repeated continuously.



All Tracks Repeat

Load the disc as usual and wait until the total playing time and track numbers appear on the display. Press the M-UP/REPEAT button twice. The REPEAT indicator remains 'On'. Press the PLAY/PAUSE **▶▶** button to begin playback. The entire disc will be repeated continuously.



To cancel Repeat Playback continue pressing the M-UP/REPEAT button until the REPEAT indicator disappears. Repeat is also canceled by opening the CD Door or switching to Tuner function.

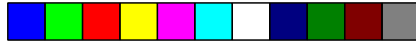

INTRO SCAN PLAYBACK (Remote Control Only)

This feature allows you to play just the first 10 seconds of each track on the disc. This may be useful when you are trying to locate a specific song but you do not remember the title.

Load the disc as usual and wait until the display shows the total playing time and number of tracks. Press the INTRO button on the remote control - there is no INTRO button on the main unit. The INTRO indicator will appear in the display. The player will play the first 10 seconds of each track automatically. When the first 10 seconds of the last track has played the player stops and the display again shows the total playing time and number of tracks on the disc.



To cancel the Intro playback mode before the disc ends press the INTRO button on the remote control once more until the INTRO indicator disappears. Intro mode can also be canceled by pressing the ■STOP/BAND button, opening the CD Door, or switching to the Tuner function.

RANDOM PLAYBACK (Remote Control Only)

This feature allows you to play all the tracks on a disc in random order.

Load the disc as usual and wait until the display shows the total playing time and number of tracks. Press the RANDOM button on the remote control - there is no RANDOM button on the main unit. The RANDOM indicator appears in the display. The tracks will be played in random order continuously.

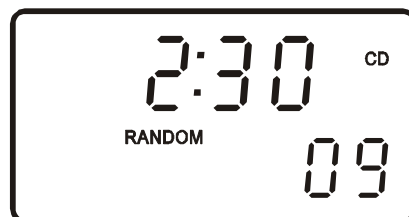

To cancel the Random mode press the RANDOM button on the remote control once more until the RANDOM indicator disappears. Random mode can also be canceled by pressing the ■STOP/BAND button, opening the CD Door, or switching to the Tuner function.

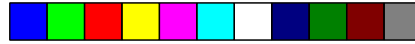

PROGRAMMED PLAYBACK

This system has a **20** track programmable memory. You can program up to **20** tracks on a disc to play back in any desired order.

NOTE: You cannot program the player while a disc is playing. You must press the ■ **STOP/BAND** button first to stop playback before beginning the programming steps below.

- 1.) Load your disc as usual and wait until the display shows the total playing time and number of tracks.

- 2.) Press the MEMORY/CLOCK ADJ. button on the front panel or the remote control. The MEMORY indicator flashes and the display show track number "01" and Program Memory number "P-01".

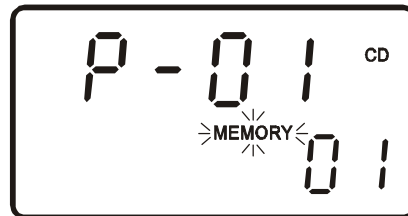

- 3.) Press the ►► or ◀◀ button on the front panel of the main unit or the remote control to select the first track you wish to program.

Example: Track 07.

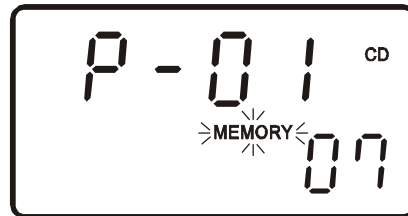

- 4.) Press the MEMORY/CLOCK ADJ. button again to enter Track 07 in Program Memory "01". The Program number advances to "P-02" and the track display shows "00".

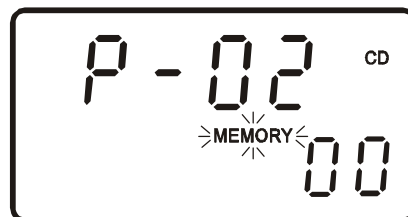

- 5.) Repeat Steps 3 and 4, selecting a different track number each time until you have entered up to **20** tracks in the memory.

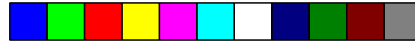

After you have programmed up to **20** tracks, press the PLAY/PAUSE ►|| button to begin programmed playback. The MEMORY indicator remains in the display and the tracks you selected will be played in the desired order. After the last programmed track has played the player stops, the MEMORY indicator disappears, and the display again shows the total tracks and playing time on the disc. However the program sequence remains in the memory.

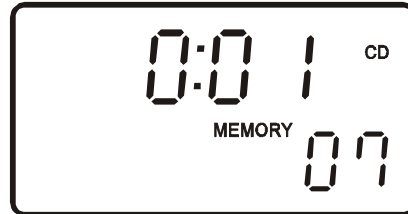

- To repeat the program sequence press the MEMORY/CLOCK ADJ. button and then press the PLAY/PAUSE ►|| button.
- To cancel programmed playback press the MEMORY/CLOCK ADJ. button and then the ■STOP/BAND button after the disc has stopped. Programmed playback can also be canceled by opening the CD Door, or by switching to the Tuner function.



PROGRAM REPEAT PLAYBACK



You may also use both the PROGRAM and REPEAT functions together to continuously repeat the programmed tracks.

- 1.) Program up to 20 tracks as described above.
- 2.) Press the M-UP/REPEAT button twice to select 'All Tracks Repeat'. The REPEAT indicator remains 'On'.
- 3.) Press the PLAY/PAUSE ►|| button to begin Programmed Repeat Playback.

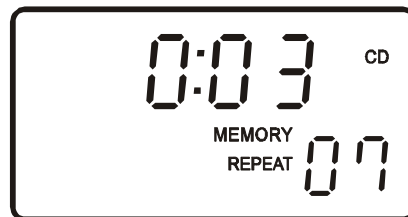

The programmed tracks will be repeated continuously.



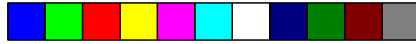

OTHER FUNCTIONS

MUTE Button (Remote Control Only)

To temporarily shut off the sound from the speakers press the MUTE button on the remote control. The MUTE indicator will appear in the display and the sound will stop. Press the MUTE button again to cancel Mute and restore the sound. The MUTE indicator will disappear from the display.



DISPLAY Button (Remote Control Only)

Normally the display shows the correct time in the Standby (Power Off) mode, the radio frequency in the Tuner mode, and the CD track and time information in the CD mode. You can press the DISPLAY button repeatedly to show the following information on the display:

- **In STANDBY (Power Off) Mode:**

Correct Time ➡ TIMER ON Time ➡ Correct Time.

- **In TUNER Mode:**

Radio Frequency ➡ Correct Time ➡ TIMER ON Time ➡ Radio Frequency.

- **In CD Playback Mode:**

CD Elapsed Time ➡ CD Remaining Time ➡ Correct Time ➡ TIMER ON Time ➡ CD Elapsed Time.

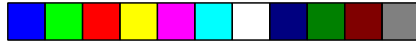

TIMER Function (Remote Control Only)

This system includes a programmable Timer function that will turn the system 'On, play for one hour, and then shut the system 'Off' automatically. You can use the timer to wake you up to the radio or to your favorite CD. The timer can be programmed while the system is in the Standby (Power Off) mode, the Tuner mode or the CD mode.

To Set The Turn On Time

- 1.) Press and hold the SLEEP/TIMER button on the front panel or the TIMER button on the remote control until "12:00 AM" appears and the TIMER indicator begins flashing in the display, then press the MEMORY/CLOCK ADJ. button for at least 3 seconds. The Hour digits begin to flash



- 2.) Press the ►► or ◄◄ button on the front panel of the main unit or the remote control to set the display to the desired turn on hour, AM or PM.

- 3.) Press the MEMORY/CLOCK-ADJ. button on the front panel or remote control. The Minute digits begin flashing.

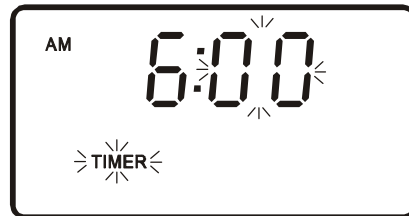

- 4.) Press the ►► or ◄◄ buttons on the front panel of the main unit or the remote control to set the display to the desired turn on minute.

- 5.) Press the MEMORY/CLOCK-ADJ. button once more to enter the turn on time in the memory. After a few seconds the TIMER display stops flashing and remains 'On' and the display returns to the correct time, the Tuner display, or the CD display.

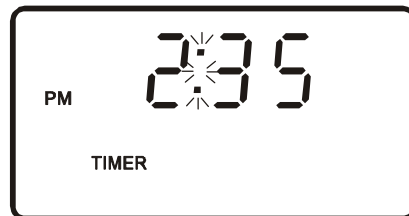

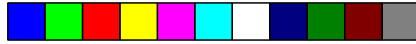

6.) At the selected 'On' time the system will turn on automatically to the last function selected, either Tuner or CD. It will play for one hour and then shut off automatically.



NOTE: If the system turns on to CD function it will only play until the end of the disc and then stop.

As long as the TIMER indicator remains in the display the timer will turn the system on every day at the same time. To deactivate the timer press and hold the SLEEP/TIMER button on the front panel or the TIMER button on the remote control until the TIMER indicator disappears from the display. To reactivate the timer press and hold the SLEEP/TIMER or TIMER buttons until the TIMER indicator reappears in the display.

SNOOZE Button (Remote Control Only)

After the timer turns the system 'On' in the morning you may press the SNOOZE button on the remote control handset for a few extra minutes sleep. The radio or CD player will turn 'Off' for five minutes, and then turn 'On' again. Snooze operation may be repeated several times if desired.





SLEEP Timer

This system includes a programmable Sleep Timer that allows you to fall asleep to between 10 and 90 minutes of music and then shuts the power 'Off' automatically.

To Operate The Sleep Timer:

- 1.) Turn the system 'On' and operate either the Tuner or CD function as usual.
- 2.) Adjust the VOLUME controls to the desired level. Remember that the level you select for the sleep to music function is the same level you will hear when the timer turns the system on in the morning.
- 3.) Press the SLEEP/TIMER button on the front panel or the SLEEP button on the remote control.

- 4.) The display will show "90" indicating that the sleep timer will shut the power off after 90 minutes. Continue pressing the SLEEP/TIMER or SLEEP button to decrease the amount of sleep timer operation. Each time you press the SLEEP or SLEEP/TIMER button you reduce the sleep time by 10 minutes. Release the SLEEP/TIMER or SLEEP button when the display shows the desired amount of Sleep timer operation.



- 5.) After a few seconds the Sleep Time display disappears and the normal Tuner or CD display returns. When the Sleep Timer counts down to "00", the power shuts off automatically.





NOTES:

- You can shut the unit off manually before the Sleep Timer counts down to “00” by pressing the POWER/STANDBY button at any time.
- Remember that if you are falling asleep to CD you will also wake to CD, and if you fall asleep to the radio you will also wake to the radio.
- If you are falling asleep to CD, the system will only operate until the CD ends. If you set the Sleep Timer for 90 minutes but your CD is only 45 minutes long, the music will stop after 45 minutes.



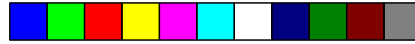

CARE AND MAINTENANCE

COMPACT DISC CARE

- To remove a disc from its storage case, press down on the center of the case and lift the disc out, holding it carefully by the edges.

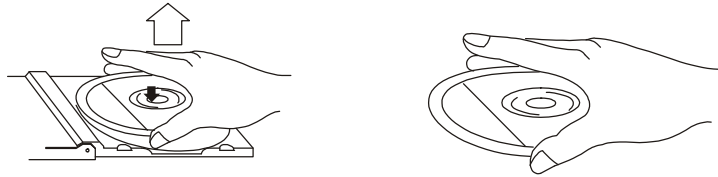

- Fingerprints and dust should be carefully wiped off the disc's recorded surface with a soft cloth. Unlike conventional records, compact discs have no grooves to collect dust and microscopic debris, so gently wiping with a soft cloth should remove most particles. Wipe in a straight line from the inside to the outside of the disc. Small dust particles and light stains will have absolutely no effect on reproduction quality.

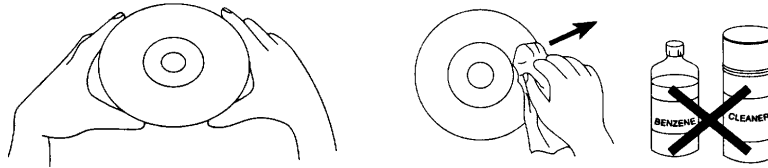

- Clean the disc periodically with a soft, lint-free, dry cloth. Never use detergents or abrasive cleaners to clean the disc. If necessary, use a CD cleaning kit.
- Never write on or affix labels to the surface of compact discs.

CARE OF THE CABINET

If the cabinet becomes dusty wipe it with a soft dry dust cloth. Do not use any wax, polish sprays, or abrasive cleaners on the cabinet.

CAUTION

Never allow any water or other liquids to get inside the unit while cleaning.

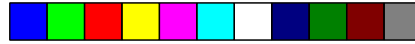

LIMITED WARRANTY

Emerson Radio Corp. warrants manufacturing defects in original material, including original parts and workmanship, under normal use and conditions, for a period of ninety (90) days from the date of original purchase in the U.S. With your dated proof of purchase, we will provide repair service at no charge for labor and parts at an authorized Depot Repair Facility, or replace the product in our discretion. For repair or replacement, pack your unit in a padded box, enclose your check or money order payable to Emerson Radio Corp. in the amount of \$9.00 (not required by California residents) to cover shipping and handling costs, and enclose a copy of your proof of purchase. Send your unit to:

Emerson Radio Corp.
1901 Diplomat Drive.
Farmers Branch, TX 75234.

This warranty does not cover damage from negligence, misuse, abuse, accident, failure to follow operating instructions, commercial use, rental, repairs by an unauthorized facility, or products purchased, used, serviced or damaged outside of the United States.

THIS WARRANTY GIVES YOU SPECIFIC LEGAL RIGHTS, AND YOU MAY ALSO HAVE OTHER RIGHTS WHICH VARY FROM STATE TO STATE.

AU898M



TO FIND THE LOCATION AND PHONE NUMBER OF YOUR NEAREST SERVICE CENTER PERMITTED TO PERFORM WARRANTY...

CALL TOLL FREE: 1-800-695-0098

FOR ADDITIONAL SET-UP OR OPERATING ASSISTANCE PLEASE CALL:
1-800-898-9020

FOR CUSTOMER SERVICE, PLEASE WRITE TO:
Emerson Radio Corp.
Consumer Affairs Dept.
1901 Diplomat Drive,
Farmers Branch, TX 75234.



EMERSON
Part No.: 16-2913
307-01

Printed in China